

EMC TEST REPORT

For

**HUIZHOU FORYOU OPTOELECTRONICS TECHNOLOGY CO.,
LTD.**

**Product Name: Photovoltaic energy storage DC integrated
machine**

Test Model(s): DA802

Report Reference No. : DACE240718006RL001

Applicant's Name : HUIZHOU FORYOU OPTOELECTRONICS TECHNOLOGY CO., LTD.

Address : Building No.6, Foryou Industrial Park Area B, No.1 North Shangxia
Road, Dongjiang High-tech Industry Park, Huizhou, Guangdong, China.

Testing Laboratory : Shenzhen DACE Testing Technology Co., Ltd.

Address : 102, Building H1, & 1/F., Building H, Hongfa Science & Technology Park,
Tangtou Community, Shiyan Subdistrict, Bao'an District, Shenzhen,
Guangdong, China

Test Specification Standard : ETSI EN 301 489-1 V2.2.3 (2019-11)
ETSI EN 301 489-3 V2.3.2 (2023-01)
ETSI EN 301 489-17 V3.2.4 (2020-09)

Date of Receipt : July 18, 2024

Date of Test : July 18, 2024 to July 29, 2024

Data of Issue : July 29, 2024

Result : **Pass**

Note: This report shall not be reproduced except in full, without the written approval of Shenzhen DACE Testing Technology Co., Ltd. This document may be altered or revised by Shenzhen DACE Testing Technology Co., Ltd. personnel only, and shall be noted in the revision section of the document. The test results in the report only apply to the tested sample

Revision History Of Report

Version	Description	REPORT No.	Issue Date
V1.0	Original	DACE240718006RL001	July 29, 2024

NOTE1:

The CE mark as shown below can be used, under the responsibility of the manufacturer, after completion of an EC Declaration of Conformity and compliance with all relevant EU Directives.



NOTE2:

The manufacturer should ensure that all products in series production are in conformity with the product sample detailed in this report. If the product in this report is used in any configuration other than that detailed in the report, the manufacturer must ensure the new system complies with all relevant standards.

Compiled by:

Ben Tang

Ben Tang / Test Engineer

Supervised by:

Stone Yin

Stone Yin / Project Engineer



Approved by:

Tom Chen

Tom Chen / Manager

CONTENTS

1	TEST SUMMARY	4
	1.1 TEST STANDARDS	4
	1.2 SUMMARY OF TEST RESULT	4
2	GENERAL INFORMATION	5
	2.1 CLIENT INFORMATION	5
	2.2 DESCRIPTION OF DEVICE (EUT)	5
	2.3 DESCRIPTION OF TEST MODES	5
	2.4 DESCRIPTION OF SUPPORT UNITS	5
	2.5 EQUIPMENTS USED DURING THE TEST	6
	2.6 STATEMENT OF THE MEASUREMENT UNCERTAINTY	6
3	EMISSION TEST RESULTS (EMI)	7
	3.1 RADIATED EMISSIONS (30MHZ-1GHZ)	7
	3.1.1 E.U.T. Operation:	7
	3.1.2 Test Setup Diagram:	7
	3.1.3 Test Data:	8
4	IMMUNITY TEST RESULTS (EMS)	10
	4.1 ELECTROSTATIC DISCHARGE	12
	4.1.1 E.U.T. Operation:	12
	4.1.2 Test Setup Diagram:	12
	4.1.3 Test Data:	12
	4.2 RADIO FREQUENCY ELECTROMAGNETIC FIELD (80 MHZ TO 6 000 MHZ)	13
	4.2.1 E.U.T. Operation:	13
	4.2.2 Test Setup Diagram:	13
	4.2.3 Test Data:	13
5	TEST SETUP PHOTOS	14
6	PHOTOS OF THE EUT	15

1 TEST SUMMARY

1.1 Test Standards

The tests were performed according to following standards:

ETSI EN 301 489-1 V2.2.3 (2019-11): ElectroMagnetic Compatibility (EMC) standard for radio equipment and services; Part 1: Common technical requirements; Harmonised Standard for ElectroMagnetic Compatibility

ETSI EN 301 489-3 V2.3.2 (2023-01): ElectroMagnetic Compatibility (EMC) standard for radio equipment and services; Part 3: Specific conditions for Short Range Devices (SRD) operating on frequencies between 9 kHz and 246 GHz; Harmonised Standard for ElectroMagnetic Compatibility

ETSI EN 301 489-17 V3.2.4 (2020-09): ElectroMagnetic Compatibility (EMC) standard for radio equipment and services; Part 17: Specific conditions for Broadbandd Data Transmission Systems; Harmonised Standard for ElectroMagnetic Compatibility

1.2 Summary of Test Result

Item	Standard	Method	Requirement	Result
Radiated emissions (30MHz-1GHz)	ETSI EN 301 489-1 V2.2.3 (2019-11);ETSI EN 301 489-17 V3.2.4 (2020-09)	EN 55032, annex A.2	EN 301 489-1, clause 8.2 EN 301 489-17, clause 7.1	Pass
Electrostatic discharge	ETSI EN 301 489-1 V2.2.3 (2019-11);ETSI EN 301 489-17 V3.2.4 (2020-09)	EN 61000-4-2, clauses 6, 7 and 8	EN 301 489-1, clause 9.3 EN 301 489-17, clause 7.2	Pass
Radio frequency electromagnetic field (80 MHz to 6 000 MHz)	ETSI EN 301 489-1 V2.2.3 (2019-11);ETSI EN 301 489-17 V3.2.4 (2020-09)	EN 61000-4-3, clauses 6, 7 and 8	EN 301 489-1, clause 9.2 EN 301 489-17, clause 7.2	Pass

2 GENERAL INFORMATION

2.1 Client Information

Applicant's Name : HUIZHOU FORYOU OPTOELECTRONICS TECHNOLOGY CO., LTD.
Address : Building No.6, Foryou Industrial Park Area B, No.1 North Shangxia Road, Dongjiang High-tech Industry Park, Huizhou, Guangdong, China.

Manufacturer : HUIZHOU FORYOU OPTOELECTRONICS TECHNOLOGY CO., LTD.
Address : Building No.6, Foryou Industrial Park Area B, No.1 North Shangxia Road, Dongjiang High-tech Industry Park, Huizhou, Guangdong, China.

2.2 Description of Device (EUT)

Product Name:	Photovoltaic energy storage DC integrated machine
Model/Type reference:	DA802
Series Model:	N/A
Trade Mark:	ADAYO
Power Supply:	DC60V14*2A
Hardware Version:	V1.0
Software Version:	V1.0
Highest Internal Frequency:	≤108MHz
Classification of Equipment:	Class B

2.3 Description of Test Modes

No	Title	Description
TM1	Working	keep the working mode

2.4 Description of Support Units

The EUT was tested as an independent device.

2.5 Equipments Used During The Test

Radiated emissions (30MHz-1GHz)					
Equipment	Manufacturer	Model No	Inventory No	Cal Date	Cal Due Date
Cable(HF)2	SCHWARZ BECK	50Ω	/	2024-03-20	2025-03-19
Cable(HF)1	SCHWARZ BECK	50Ω	/	2024-03-20	2025-03-19
Cable(LF)2	SCHWARZ BECK	50Ω	/	2024-03-20	2025-03-19
Cable(LF)1	SCHWARZ BECK	50Ω	/	2024-03-20	2025-03-19
control	Positioning Controller	Model MF-7802	MF780208362	2023-12-27	2024-12-26
Test Receiver	Rohde & Schwarz	ESPI TEST RECEIVER	ID:1164.6607K 03-102109-MH	2024-06-12	2025-06-11
EMI Test software	Farad	EZ -EMC	V1.1.42	/	/
Positioning Controller	/	MF-7802	/	/	/
Amplifier(18-40G)	COM-POWER	AH-1840	10100008-1	2022-04-05	2025-04-04
Horn antenna	COM-POWER	AH-1840 (18-40G)	10100008	2023-04-05	2025-04-04
Loop antenna	ZHINAN	ZN30900C	ZN30900C	2024-06-14	2026-06-13
Power amplifier(LF)	Schwarzbeck	BBV9743	9743-151	2024-06-12	2025-06-11
Power amplifier(HF)	Schwarzbeck	BBV9718	9718-282	2024-06-12	2025-06-11
Horn Antenna	Sunol Sciences	DRH-118	A091114	2023-05-13	2025-05-12
Broadband Antenna	Sunol Sciences	JB6 Antenna	A090414	2023-05-21	2025-05-20

Electrostatic discharge					
Equipment	Manufacturer	Model No	Inventory No	Cal Date	Cal Due Date
ESD Tester	Prima	ESD61002A	144305	2023-12-11	2024-12-10

2.6 Statement Of The Measurement Uncertainty

Test Item	Measurement Uncertainty
Radiated Emission (Below 1GHz)	±5.79dB
Note: (1) This uncertainty represents an expanded uncertainty expressed at approximately the 95% confidence level using a coverage factor of k=2.	

3 Emission Test Results (EMI)

3.1 Radiated emissions (30MHz-1GHz)

Test Requirement:	EN 301 489-1, clause 8.2 EN 301 489-17, clause 7.1		
Test Limit:	FREQUENCY (MHz)	dB(μV/m) At 10m	dB(μV/m) At 3m
	30MHz-230MHz	30	40
	230MHz-1GHz	37	47
	Detector: Peak for pre-scan (120kHz resolution bandwidth) 30M to 1000MHz		
Test Method:	EN 55032, annex A.2		
Procedure:	An initial pre-scan was performed in the chamber using the spectrum analyser in peak detection mode. Quasi-peak measurements were conducted based on the peak sweep graph. The EUT was measured by BiConiLog antenna with 2 orthogonal polarities. Remark: Level= Read Level+ Cable Loss+ Antenna Factor- Preamp Factor		

3.1.1 E.U.T. Operation:

Operating Environment:			
Temperature:	22.5 °C	Humidity:	49 %
Pretest mode:		TM1	
Final test mode:		TM1	

3.1.2 Test Setup Diagram:

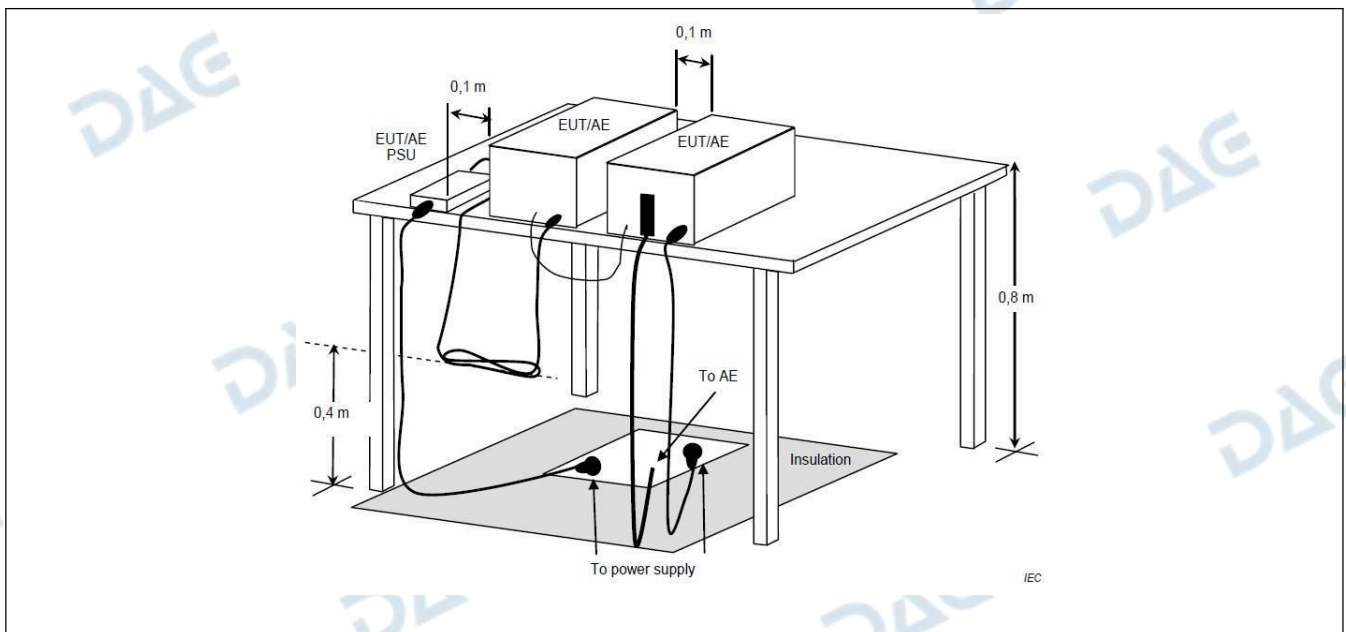

3.1.3 Test Data:

TM1 / Polarization: Horizontal

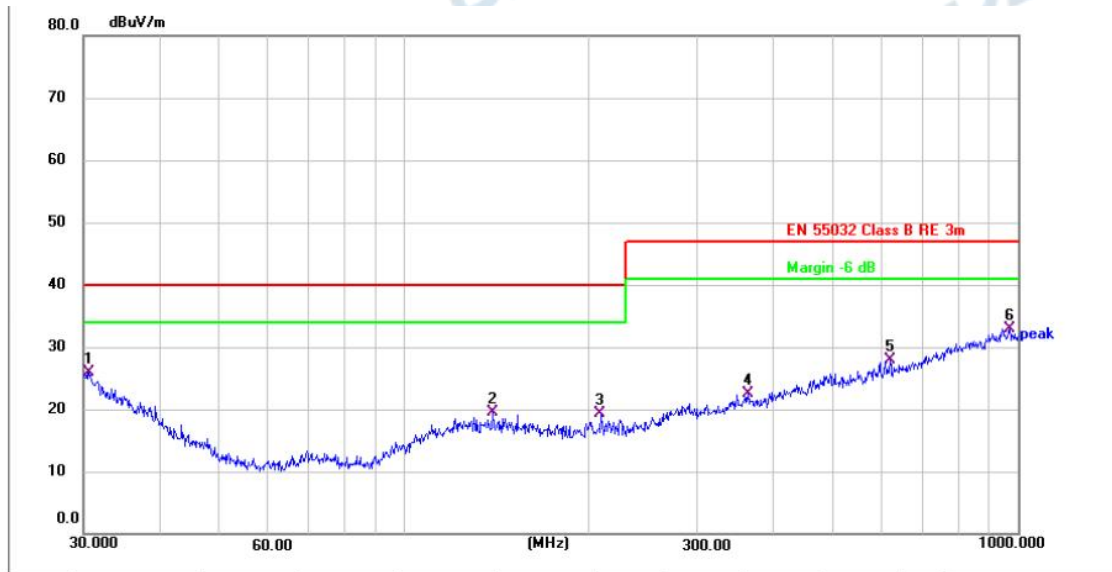

No.	Frequency (MHz)	Reading (dBuV)	Factor (dB/m)	Level (dBuV/m)	Limit (dBuV/m)	Margin (dB)	Detector	Height (cm)	Azimuth (deg.)	P/F	Remark
1	30.6379	26.07	-0.20	25.87	40.00	-14.13	QP	100		P	
2	139.3613	27.62	-8.07	19.55	40.00	-20.45	QP	100		P	
3	209.3129	27.81	-8.60	19.21	40.00	-20.79	QP	100		P	
4	362.9844	27.10	-4.53	22.57	47.00	-24.43	QP	100		P	
5	618.5369	27.32	0.49	27.81	47.00	-19.19	QP	100		P	
6 *	968.9338	27.07	5.92	32.99	47.00	-14.01	QP	100		P	

TM1 / Polarization: Vertical

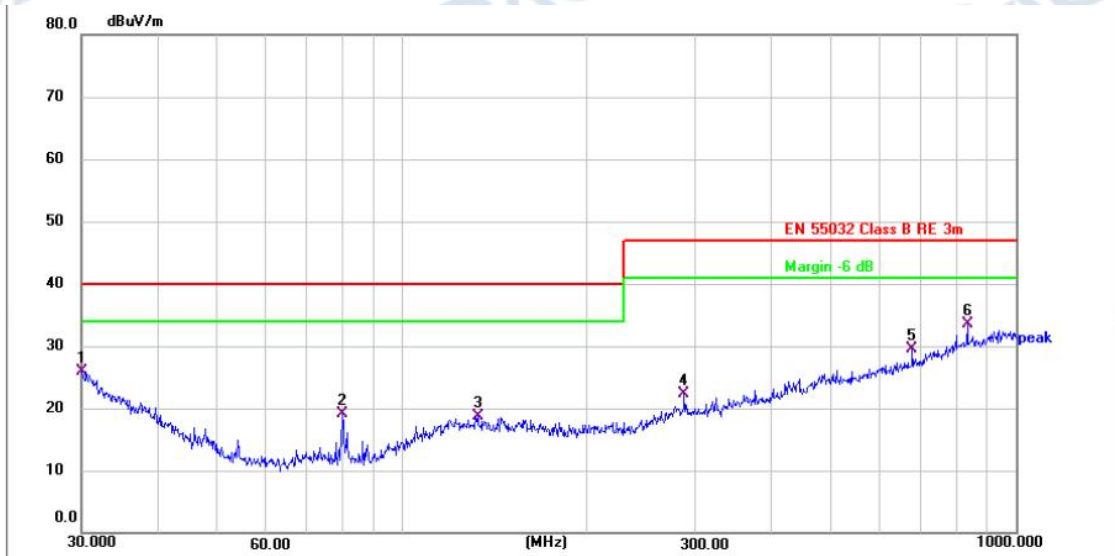

No.	Frequency (MHz)	Reading (dBuV)	Factor (dB/m)	Level (dBuV/m)	Limit (dBuV/m)	Margin (dB)	Detector	Height (cm)	Azimuth (deg.)	P/F	Remark
1	30.1054	25.67	0.19	25.86	40.00	-14.14	QP	100		P	
2	79.8003	33.23	-14.14	19.09	40.00	-20.91	QP	100		P	
3	132.6850	26.56	-7.81	18.75	40.00	-21.25	QP	100		P	
4	287.9904	28.24	-6.03	22.21	47.00	-24.79	QP	100		P	
5	677.5798	27.98	1.57	29.55	47.00	-17.45	QP	100		P	
6 *	833.3171	29.09	4.49	33.58	47.00	-13.42	QP	100		P	

4 Immunity Test Results (EMS)

Performance Criteria for ETSI EN 301 489-1 V2.2.3 (2019-11)

Continuous phenomena:

During the test, the equipment shall:

- continue to operate as intended;
- not unintentionally transmit;
- not unintentionally change its operating state;
- not unintentionally change critical stored data.

Continuous and non-continuous operation

Latency is the time delay between the initiation and the completion of operation of the EUT.

Correct functioning requires completing the relevant operation within the maximum latency time.

Where the maximum latency is specified in the applicable harmonised radio standard (in the wanted performance criterion, or an acknowledge requirement), that value shall be used.

Where this is not the case, then the maximum latency is that required by the intended use of the EUT.

Operating modes

Where the EUT has more than one mode of operation (see clause 4.4.1), an unplanned transition from one mode to another is considered as an unintentional response. The EUT shall be tested in all modes to confirm there are no such unintentional responses.

Transient phenomena:

For all ports and transient phenomena with the exception described below, the following applies:

- The application of the transient phenomena shall not result in a change of the mode of operation (e.g. unintended transmission) or the loss of critical stored data.
- After application of the transient phenomena, the equipment shall operate as intended.

For surges applied to symmetrically operated wired network ports intended to be connected directly to outdoor lines the following criteria applies:

- For products with only one symmetrical port intended for connection to outdoor lines, loss of function is allowed, provided the function is self-recoverable, or can be otherwise restored. Information stored in non-volatile memory, or protected by a battery backup, shall not be lost.
- For products with more than one symmetrical port intended for connection to outdoor lines, loss of function on the port under test is allowed, provided the function is self-recoverable. Information stored in non-volatile memory, or protected by a battery backup, shall not be lost.

Continuous and non-continuous operation

Latency is the time delay between the initiation and the completion of operation of the EUT.

Correct functioning requires completing the relevant operation within the maximum latency time.

Where the maximum latency is specified in the applicable harmonised radio standard (in the wanted performance criterion, or an acknowledge requirement), that value shall be used.

Where this is not the case, then the maximum latency is that required by the intended use of the EUT.

Operating modes

Where the EUT has more than one mode of operation (see clause 4.4.1), an unplanned transition from one mode to another is considered as an unintentional response. The EUT shall be tested in all modes to confirm there are no such unintentional responses.

Performance Criteria for ETSI EN 301 489-17 V3.2.4 (2020-09)

Performance criteria

General performance criteria

The performance criteria are:

- performance criteria A for immunity tests with phenomena of a continuous nature;
- performance criteria B for immunity tests with phenomena of a transient nature;
- performance criteria C for immunity tests with power interruptions exceeding a certain time.

The equipment shall meet the minimum performance criteria as specified in the following clauses.

Performance table

Performance criteria overview

Table 2: Performance criteria

Criteria	During test	After test (i.e. as a result of the application of the test)
A	Shall operate as intended.	Shall operate as intended.

	(See note). Shall be no loss of function. Shall be no unintentional transmissions.	Shall be no degradation of performance. Shall be no loss of function. Shall be no loss of critical stored data.
B	May be loss of function.	Functions shall be self-recoverable. Shall operate as intended after recovering. Shall be no loss of critical stored data.
C	May be loss of function.	Functions shall be recoverable by the operator. Shall operate as intended after recovering. Shall be no loss of critical stored data.
NOTE: Operate as intended during the test allows a level of degradation in accordance with clause 6.2.2.		

Minimum performance level

For equipment that supports a PER or FER, the minimum performance level shall be a PER or FER less than or equal to 10 %.

For equipment that does not support a PER or a FER, the minimum performance level shall be no loss of the wireless transmission function needed for the intended use of the equipment.

Performance criteria for Continuous phenomena

The performance criteria A shall apply.

Where the EUT is a transmitter in standby mode, unintentional transmission shall not occur during the test.

Where the EUT is a transceiver in receive mode, unintentional transmission shall not occur during the test.

Performance criteria for Transient phenomena

The performance criteria B shall apply, except for voltage dips greater than or equal to 100 ms and voltage interruptions of 5 000 ms duration, for which performance criteria C shall apply.

Where the EUT is a transmitter in standby mode, unintentional transmission shall not occur as a result of the application of the test.

Where the EUT is a transceiver in receive mode, unintentional transmission shall not occur as a result of the application of the test.

4.1 Electrostatic discharge

Test Requirement:	EN 301 489-1, clause 9.3 EN 301 489-17, clause 7.2
Test Method:	EN 61000-4-2, clauses 6, 7 and 8
Procedure:	Discharge Impedance: 330Ω/150pF Number of Discharge: Minimum 10 times at each test point Discharge Mode: Single Discharge Discharge Period: 1 second minimum
Performance Criteria:	TT(B), TR(B)

4.1.1 E.U.T. Operation:

Operating Environment:					
Temperature:	22.5 °C	Humidity:	49 %	Atmospheric Pressure:	102 kPa
Pretest mode:	TM1				
Final test mode:	TM1				

4.1.2 Test Setup Diagram:

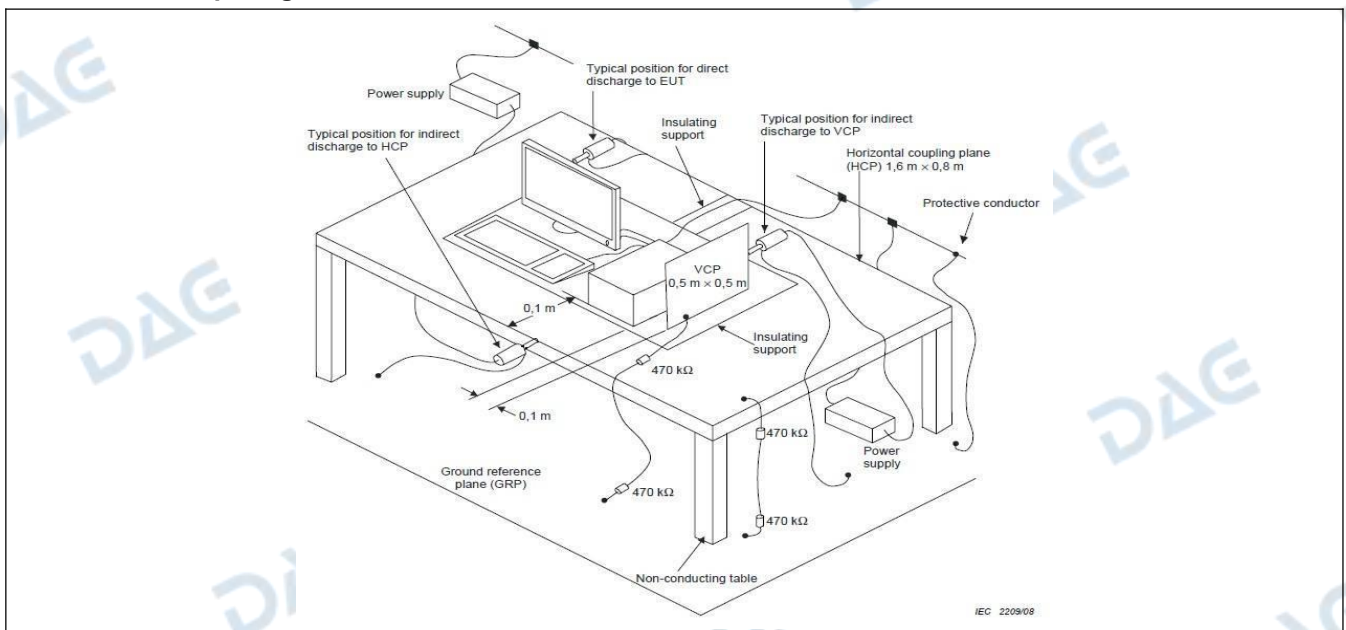

4.1.3 Test Data:

Discharge type	Volt (kV)	Polarity	Test Point	Result/ Observations
Air discharge	2,4,8	+	13	A
Air discharge	2,4,8	-	13	A
Contact discharge	4	+	2	A
Contact discharge	4	-	2	A
Horizontal Coupling	4	+	3	A
Horizontal Coupling	4	-	3	A
Vertical Coupling	4	+	3	A
Vertical Coupling	4	-	3	A

Test Point: 1. All insulated enclosure and seams.
 2. All accessible metal parts of the enclosure.
 3. All side.
 A: No degradation in the performance of the EUT was observed.

4.2 Radio frequency electromagnetic field (80 MHz to 6 000 MHz)

Test Requirement:	EN 301 489-1, clause 9.2 EN 301 489-17, clause 7.2
Test Method:	EN 61000-4-3, clauses 6, 7 and 8
Procedure:	Frequency Range: 80MHz to 6GHz Antenna Polarisation: Vertical and Horizontal Modulation: 1kHz,80% Amp. Mod,1% increment
Performance Criteria:	CT(A), CR(A)

4.2.1 E.U.T. Operation:

Operating Environment:					
Temperature:	22.5 °C	Humidity:	49 %	Atmospheric Pressure:	102 kPa
Pretest mode:	TM1				
Final test mode:	TM1				

4.2.2 Test Setup Diagram:

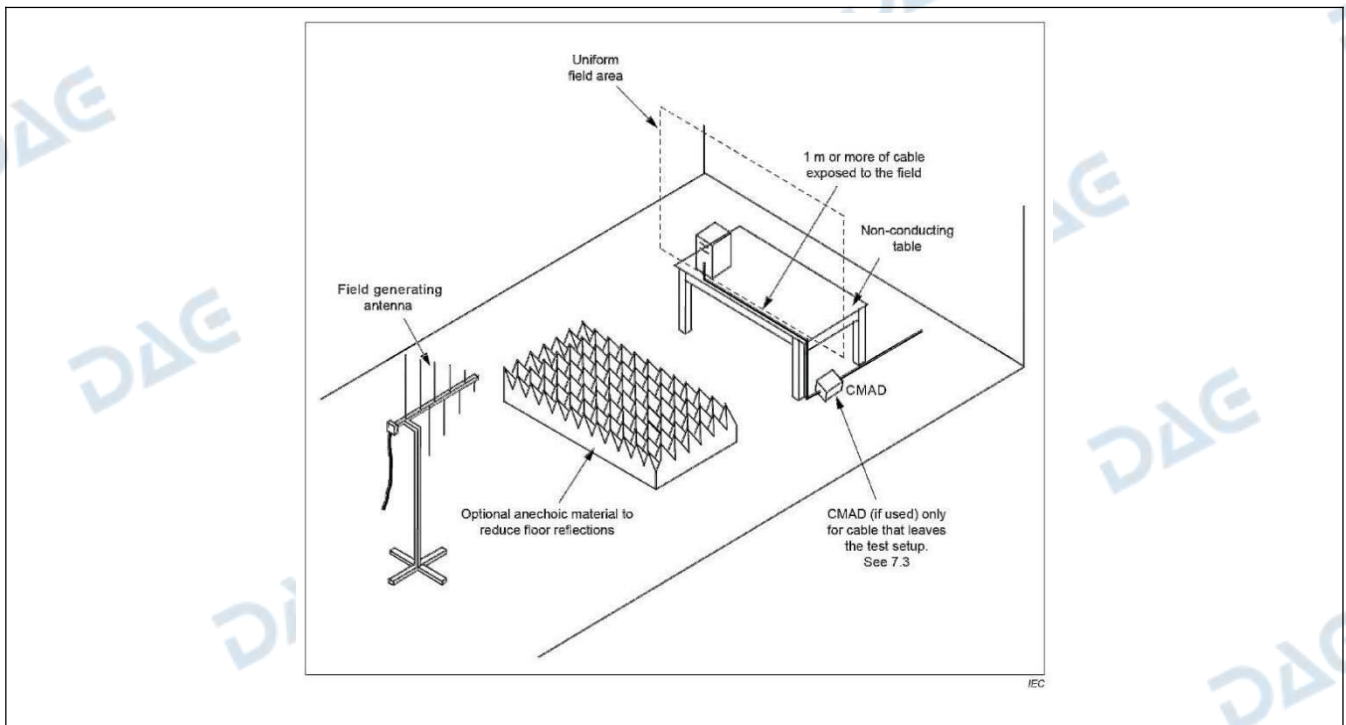

4.2.3 Test Data:

Frequency	Field Strength (V/m)	EUT face	Dwell time	Result/ Observations
80MHz-6GHz	3	Front	3s	A
80MHz-6GHz	3	Back	3s	A
80MHz-6GHz	3	Left	3s	A
80MHz-6GHz	3	Right	3s	A
80MHz-6GHz	3	Top	3s	A
80MHz-6GHz	3	Bottom	3s	A

A: No degradation in the performance of the EUT was observed.

5 TEST SETUP PHOTOS

Radiated emissions (30MHz-1GHz)

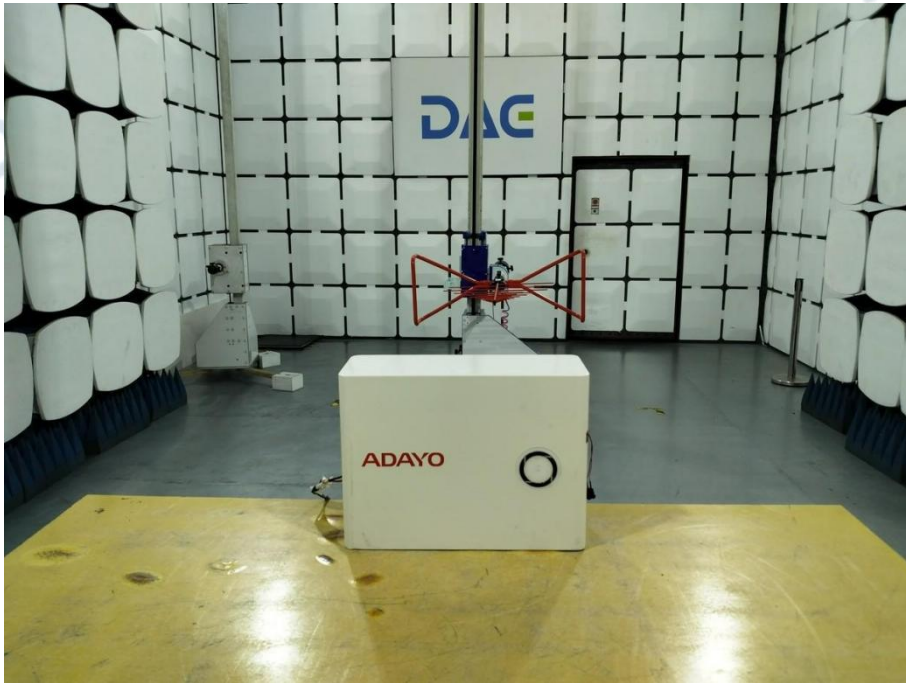

Electrostatic discharge



6 PHOTOS OF THE EUT

External

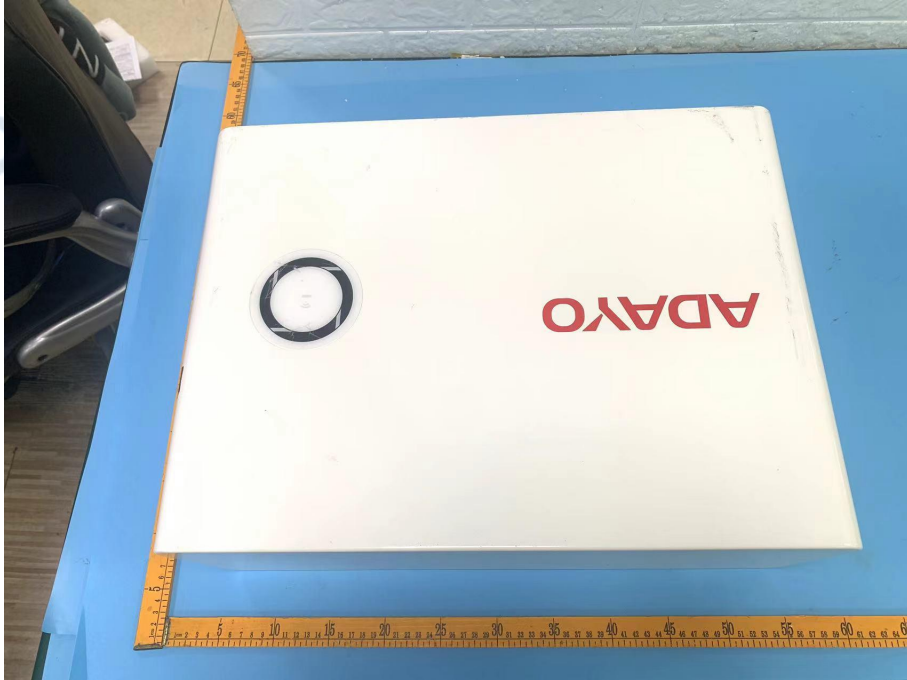

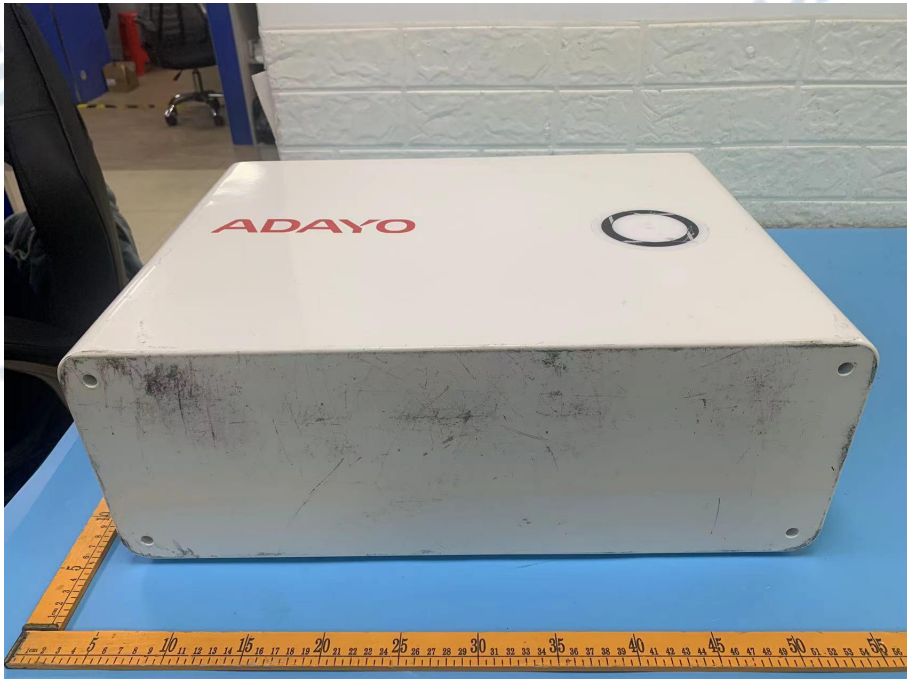
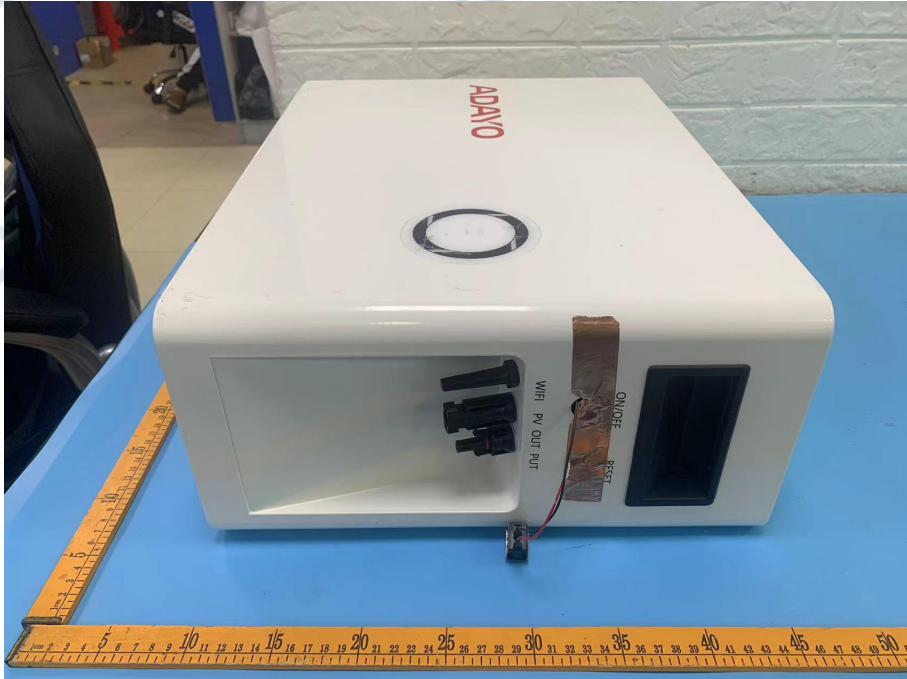



Internal

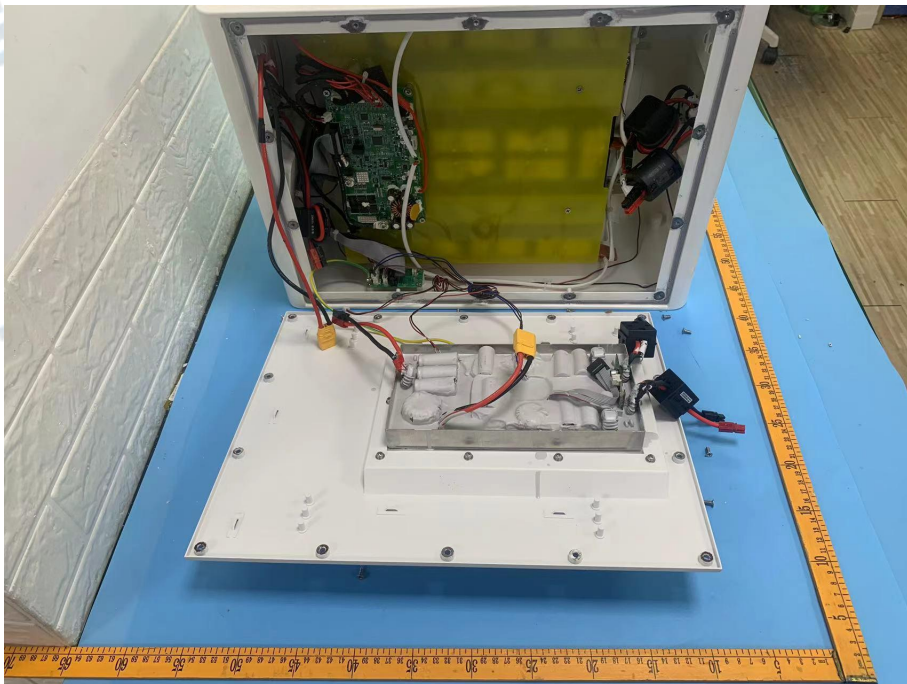

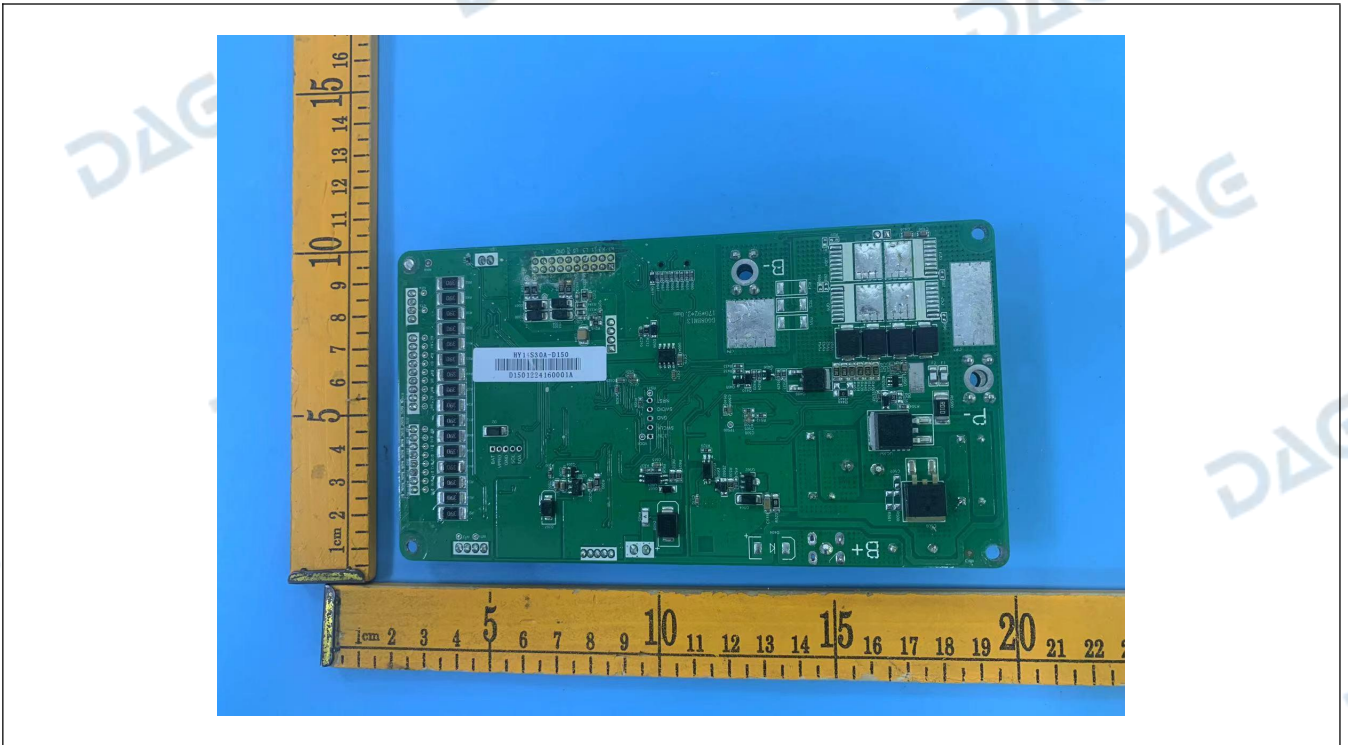
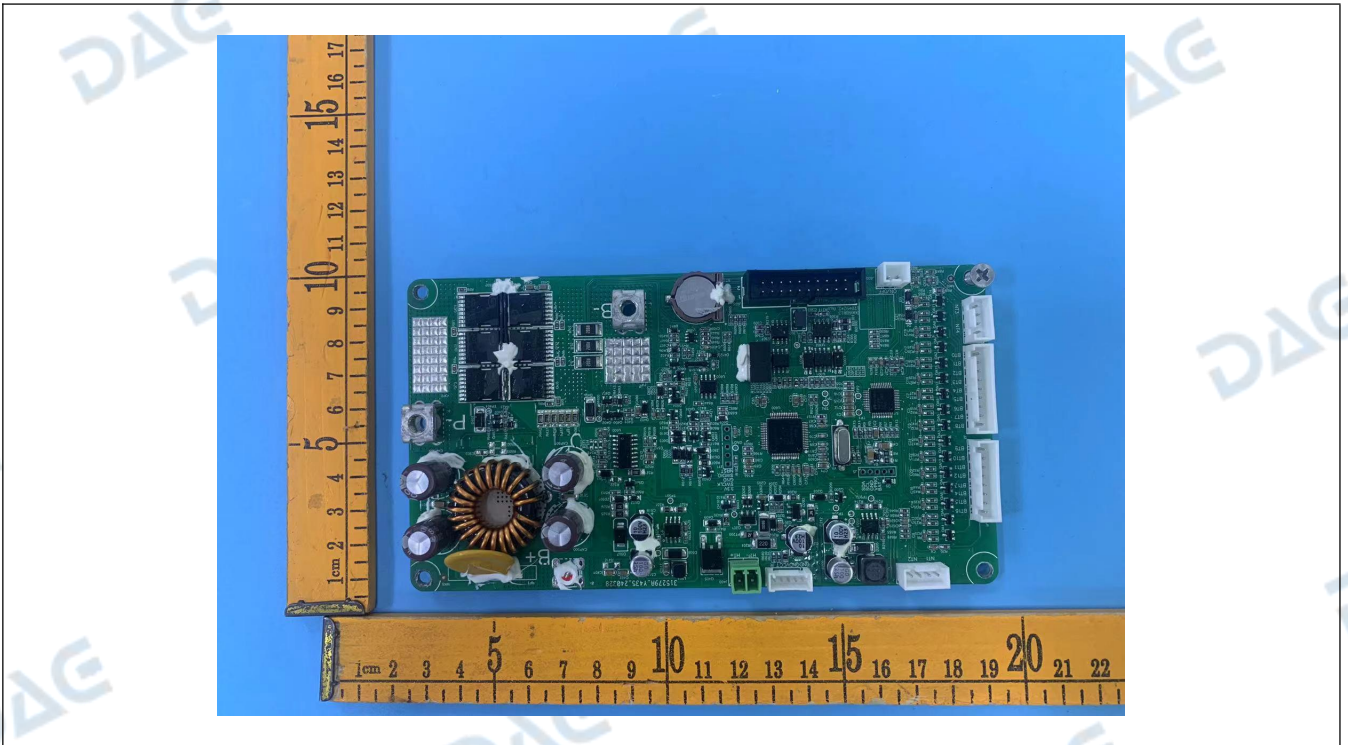

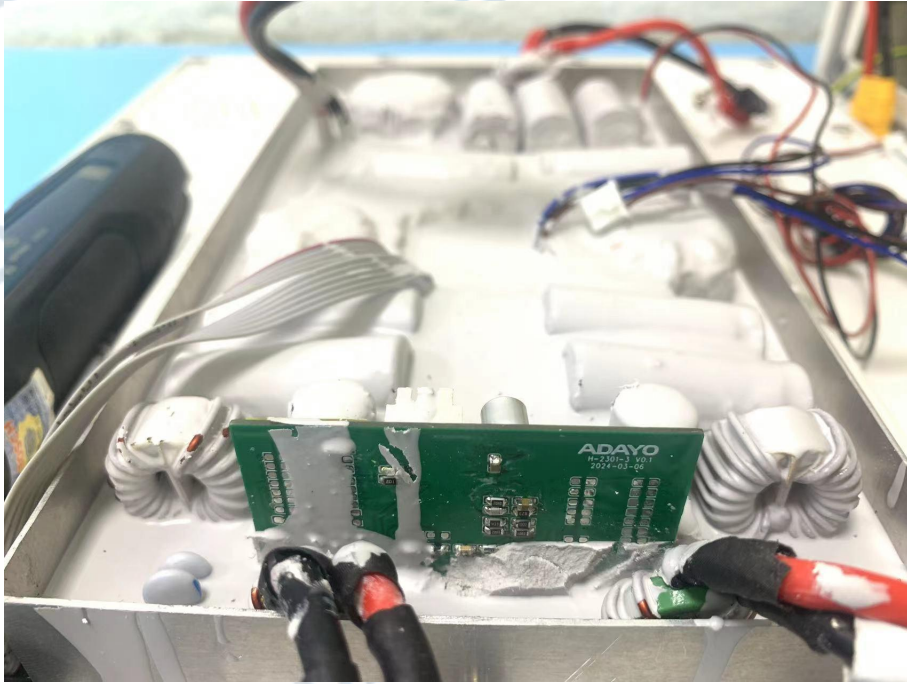

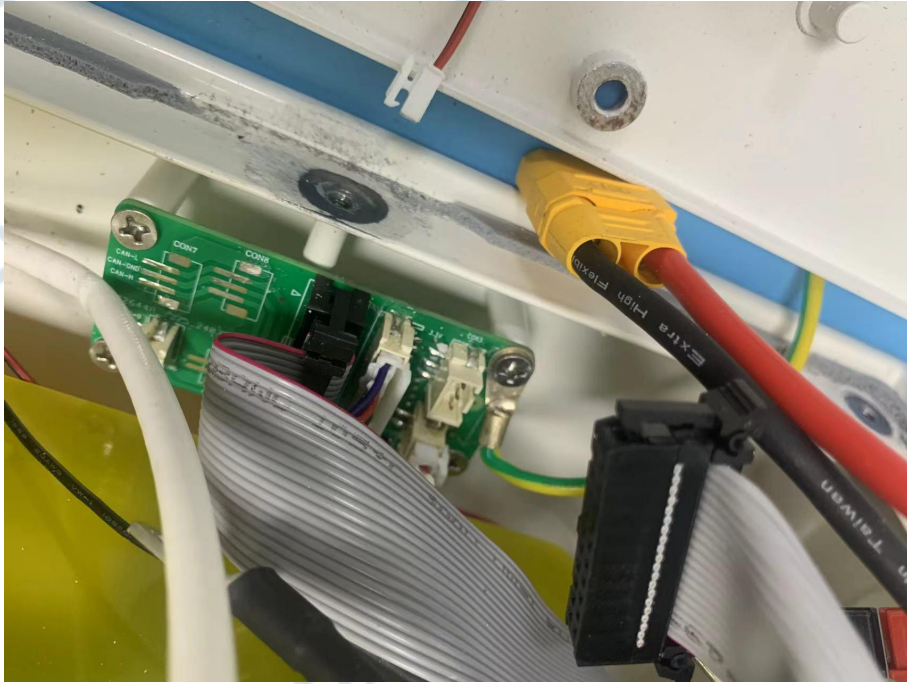

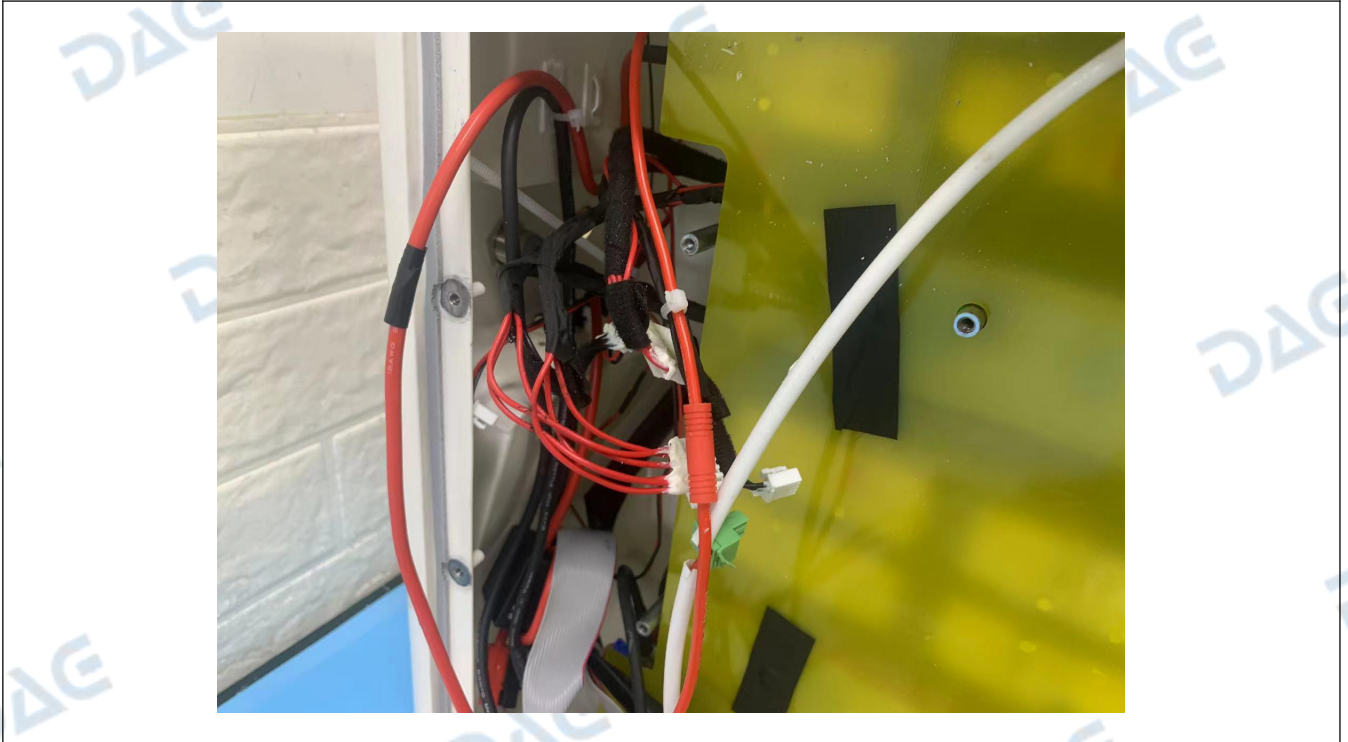

***** End of Report *****